

AM/FM STEREO TUNER

TX-8500II

OPERATING INSTRUCTIONS

KU
KC

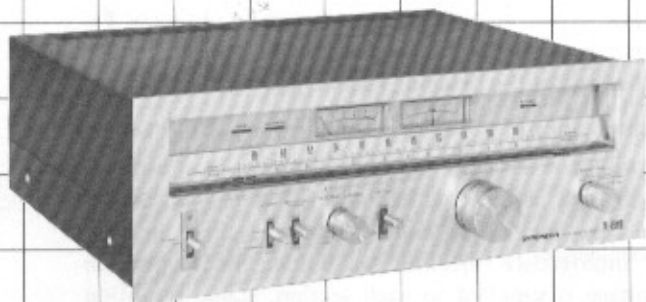

 PIONEER®

WARNING: TO PREVENT FIRE OR SHOCK HAZARD,
DO NOT EXPOSE THIS APPLIANCE TO RAIN OR
MOISTURE.

FEATURES

Full Performance FM Front End

The 1st stage RF amplifier front end includes a 4-gang variable capacitor and high gain low noise dual gate MOS FET circuit. In addition to advanced spurious, image and other types of interfering signal rejection capability, high sensitivity and excellent strong signal input response are obtained. A wide air spaced variable capacitor is also employed in the local oscillator circuit for increasing tuning scale accuracy.

Selectable Bandwidth IF Amplifier

According to signal conditions, the IF amplifier can be selected for wide band (high fidelity) and narrow band (high selectivity) modes. A 2 element phase linear ceramic filter is used in the wide band mode, improving phase response to allow FM reception with excellent linearity and fidelity. The narrow band mode utilizes 4 dual element ceramic filters to obtain an effective selectivity of 80dB. Interference-free reception becomes possible even in locations where a strong interfering signal is adjacent to a desired station.

Automatic Pilot Signal Cancelling Circuit

Earlier multiplex circuit designs employed 19kHz pilot signal blocking filters and thus exhibited a hint of reduction in frequency response at the high end of the band. This drawback is overcome by a newly developed PLL IC which includes an automatic pilot signal cancelling circuit. Since carrier leakage can also be amply suppressed, the new device actually extends frequency response at high frequencies. The demodulator includes a negative feedback (NFB) circuit for improved SN ratio and minimum distortion.

Built-in Rec Level Check Oscillator

Proper tape deck recording level settings and correct antenna direction are important factors in producing quality recordings of FM broadcasts. The built-in reference signal oscillator provides a 440Hz toneburst signal at a level corresponding to 50% FM modulation for use as a recording level check signal. In addition to use when recording of FM programs, this feature is also valuable for balancing the stereo channels of the listening room equipment.

AM Tuner Includes Newly Developed IC

Tuned type AM RF amplifier circuit incorporates a newly developed high sensitivity, low distortion IC and 2-gang variable capacitor. These contribute to advanced imaging and RF interference rejection capabilities. Since optimum AGC voltage is supplied to each section, stable reception can be obtained with low spurious interference and distortion even in high field strength areas.

AF IC Includes Built-in Muting Circuit

Full NFB is applied in the wide dynamic range differential direct coupled audio frequency amplifier circuit, while the muting circuit incorporates the most recent electronic circuit technology. By including both these circuits in a newly developed IC, low distortion and high S/N are realized which approach the values associated with test instrumentation. Smooth, noise-free reception is thus assured.

CONTENTS

Features	2	Listening to Broadcasts	6
Installation Cautions	3	Effective Operation	8
Connection Diagram	3	FM-Dolby Reception	10
Connections	4	Specifications	11
Antenna Connections	4	Conditions Frequently Mistaken for	
Front Panel Facilities	6	Malfunction	12

INSTALLATION CAUTIONS

To ensure long term reliable performance, avoid installing the TX-8500II in locations such as the following:

Locations to be avoided	Possible detrimental effects
<ul style="list-style-type: none"> • Direct sunlight, radiators or other heat sources. Above or near high power stereo amplifiers or power transformers. • Sites subject to poor ventilation, high humidity or moisture. • Dusty locations • Where AM radio or TV set is being used simultaneously. • Locations where alcohol, insect sprays or volatile materials are used or stored. 	<ul style="list-style-type: none"> • External heating can cause deterioration of circuit components and may prevent stable operation. • Corrosion of terminal contacts which can lead to faulty connections. Humidity and moisture can also cause defective insulation, present the risk of leakage currents and overheating of circuit components. • Internal accumulations of dust can absorb moisture and lead to faulty insulation. • Mutual interference can occur from oscillator circuits used in these products. • Appearance and finish of front panel can be damaged.

CONNECTION DIAGRAM

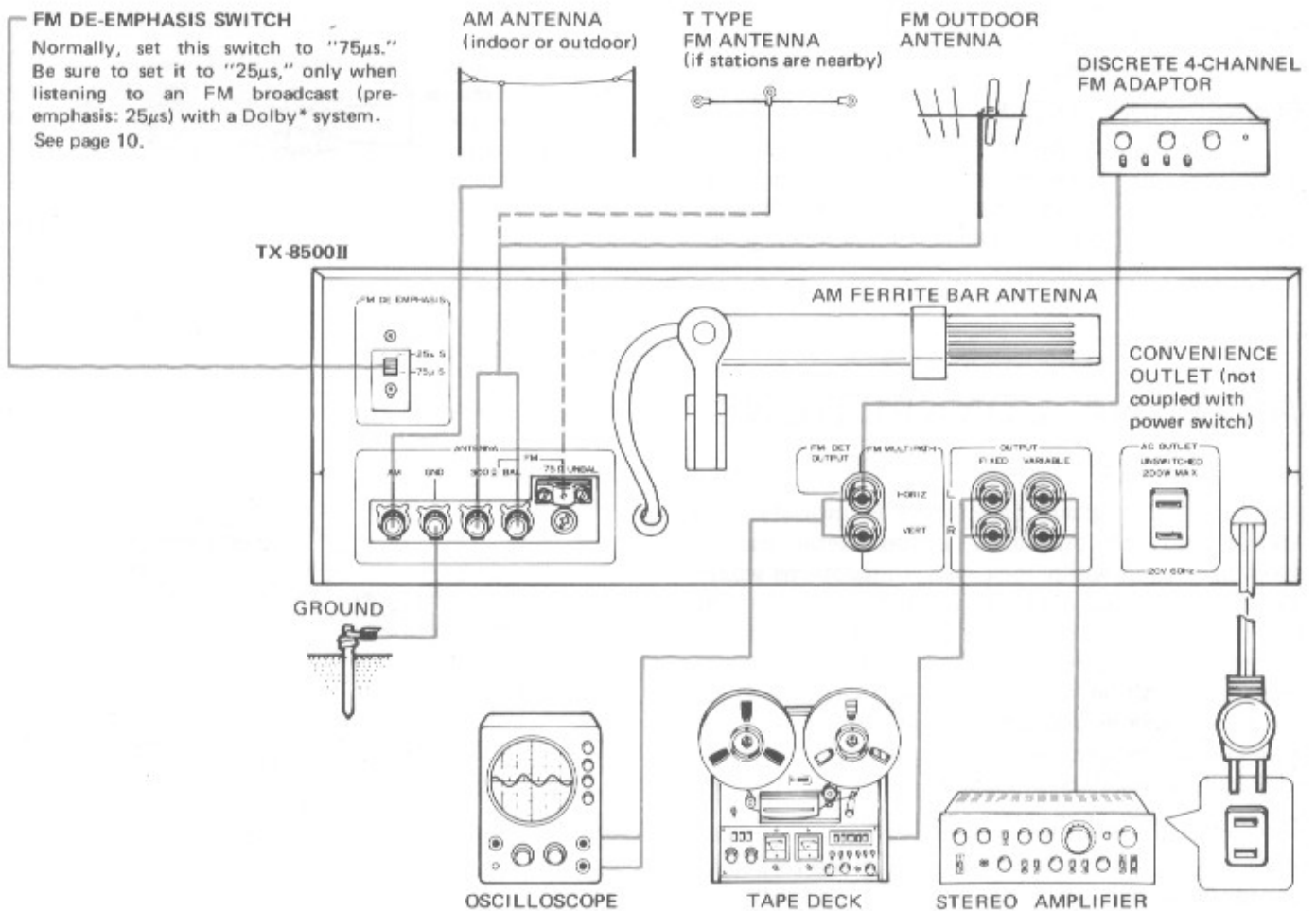

* The word "Dolby" is a trademark of Dolby Laboratories Inc.

CONNECTIONS

Connection Notes

- Output level at the OUTPUT (VARIABLE) jacks is adjustable with the front panel OUTPUT LEVEL control. Output level at the FIXED jacks is not adjustable.
- Upper jack of each pair is for the left (L) channel and lower jack for the right (R) channel. As stereo amplifier and tape deck are also provided with L and R channel jacks, use care to connect the channels correctly (L to L and R to R) in order to obtain proper stereo reproduction.
- Plug connecting cords firmly into the jacks. Loose connections can cause absence of sound or noise.
- Do not bundle input and output cords with power and speaker cords. Also avoid using longer cords than necessary. These practices can result in noise, impaired sound quality and possible operating difficulties.

CONNECTIONS TO STEREO AMPLIFIER

Use the accessory connecting cords to connect the OUTPUT (VARIABLE) jacks with the tuner jacks of a stereo amplifier.

CONNECTIONS TO TAPE DECK

A tape deck can be connected directly to the TX-8500II to allow recording from broadcasts. Connect the recording input (LINE INPUT) jacks of the tape deck to the OUTPUT (FIXED) jacks.

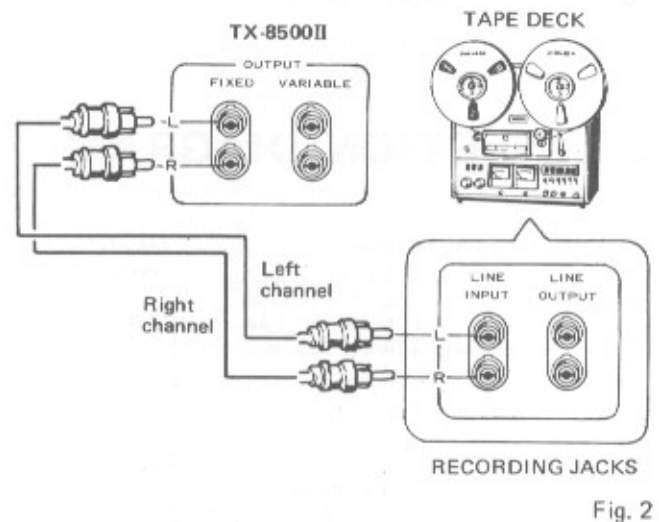
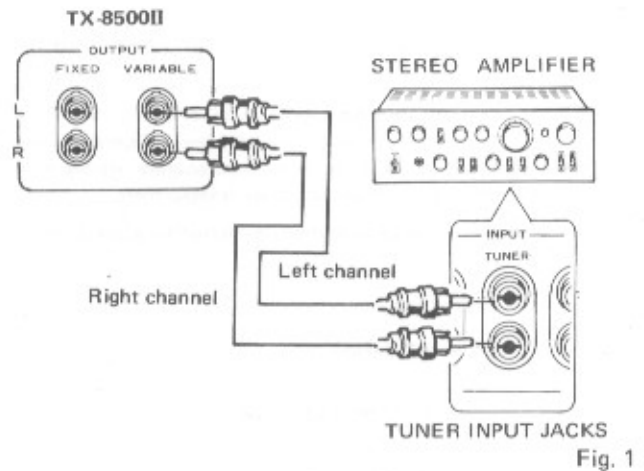

ANTENNA CONNECTIONS

FM ANTENNAS

FM broadcast signals deteriorate in mountainous areas, amid tall buildings, within metal framed structures and similar locations. In locations where signals are weak, reflected signals from mountains and man-made structures can be picked up by the antenna to produce multipath distortion. For these reasons, both the antenna and its installation site must be selected according to ambient conditions and signal strength. See additional description of multipath distortion on Page 9.

Outdoor FM Antennas

An outdoor FM antenna is recommended to obtain an input signal with which the TX-8500II can display its full performance capabilities.

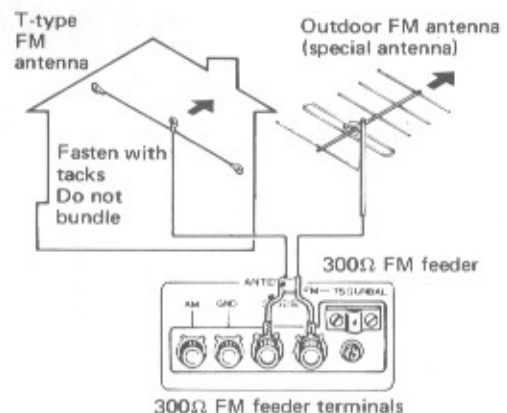

- While listening to an FM station (see FM Reception on Page 6), determine the antenna direction for optimum reception, then install it securely.
- According to type of antenna, employ 300ohm feeder or 75ohm coaxial cable for connection.

300ohm feeder: This is suitable in locations where external noise is not a problem and if the distance between the antenna and the TX-8500II is short. Connect to the 300ohm BAL terminals as shown in Fig. 3.

75ohm coaxial cable: Recommended in locations where external noise is incurred due to street traffic, high voltage power lines or other causes. Also employed if distance between antenna and TX-8500II is relatively large. Connect to the 75ohm UNBAL terminal as shown in Fig. 4.

NOTE:

Consult a reliable audio dealer regarding FM antenna and 75ohm cable installation.

T Type Dipole FM Antenna

The accessory T type FM antenna can be employed in locations where FM signals are strong, such as those near transmitting stations or within wooden structures. As shown in Fig. 3, connect the T type FM antenna to the 300ohm BAL terminals. While listening to FM stations, open the antenna to a T shape, rotate it 180° to determine where the best reception is obtained, then attach it to a wall or ceiling.

AM ANTENNAS

While listening to AM stations (see AM Reception on Page 7), move the rear panel ferrite bar antenna and position it for best reception.

- In cases when the bar antenna is insufficient for adequate reception, an indoor AM antenna can be made from a length (5 to 6 meters) of vinyl insulated wire. As shown in Fig. 6, connect one end of the wire to the AM antenna terminal and suspend the free end from a wall or ceiling at as high a location as possible.
- If reception is still difficult with an indoor antenna, use vinyl insulated wire to erect an outdoor AM antenna between two supports as shown in Fig. 6.

GROUNDING

From aspects of both safety and reduced noise, if possible employ a ground as shown in Fig. 6. Connect the ground lead to the GND terminal of the TX-8500II. Consult a qualified electrician regarding proper grounding techniques.

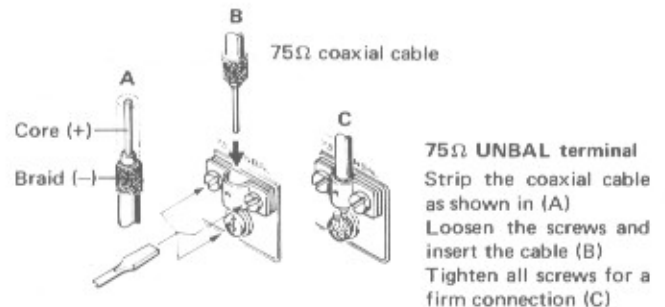

Fig. 4



Fig. 5

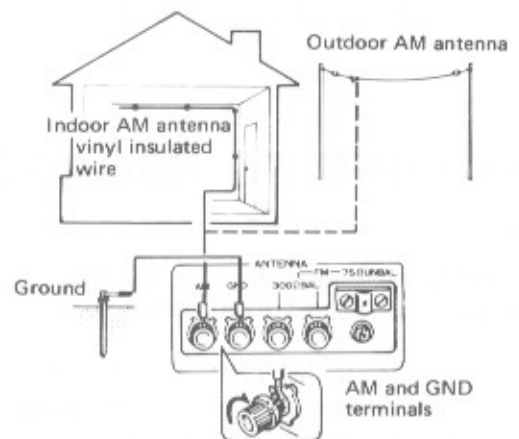

Fig. 6

FRONT PANEL FACILITIES

POWER SWITCH

Set to ON position to turn on power. Pilot lamp will light.

IF BAND SWITCH

FM IF (intermediate frequency) passband can be set to for wide or narrow.

WIDE: Normally set switch to this position.

NARROW: If adjacent station interference is a problem at the WIDE setting, set switch to this position.

See further description under heading "IF BAND Switch" on Page 8.

REC LEVEL CHECK SWITCH

When set to ON, a 440Hz signal (level corresponding to 50% FM modulation) is produced at approximately 1.7 second intervals. Employ for setting tape deck recording levels. This feature does not operate if the FUNCTION switch is set to AM. For additional information, see "REC LEVEL CHECK" on Page 8.

SIGNAL METER

Employ when tuning AM and FM stations. Optimum tuning point occurs when maximum meter deflection toward the right is obtained.

PILOT LAMP

IF BAND INDICATOR

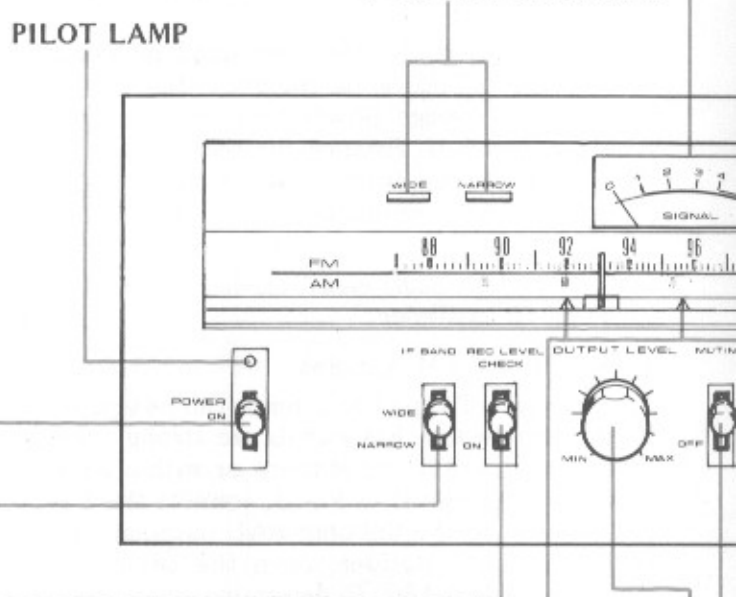

MEMORY MARKERS

Convenient for designating most often tuned in stations. Slide markers with fingertip to desired positions.

OUTPUT LEVEL CONTROL

Adjust level at OUTPUT (VARIABLE) jacks. Clockwise rotation increases output level. See "OUTPUT jacks and OUTPUT LEVEL control" on Page 8.

LISTENING TO BROADCASTS

FM RECEPTION

1. Set FUNCTION switch to FM AUTO.
2. Set REC LEVEL CHECK switch to upper position.
3. Normally set the MUTING switch to the upper position. However, in locations where signals are very weak, set switch to OFF.
4. Set IF BAND switch to WIDE. If reception of desired station is difficult due to interference from an adjacent station, set this switch to NARROW.
5. Turn the TUNING knob to select desired station. Tune for maximum deflection of the SIGNAL meter toward the right and center of

scale indication on the TUNING meter, as shown in Fig. 7. The STEREO indicator lights during FM stereo reception. It does not light during monophonic reception.

- If signals are weak or noisy, it may be advisable to set to FM MONO.
- If comparatively high frequency noise becomes objectionable during FM stereo reception, set switch to FM NOISE FILTER.

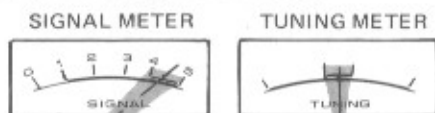
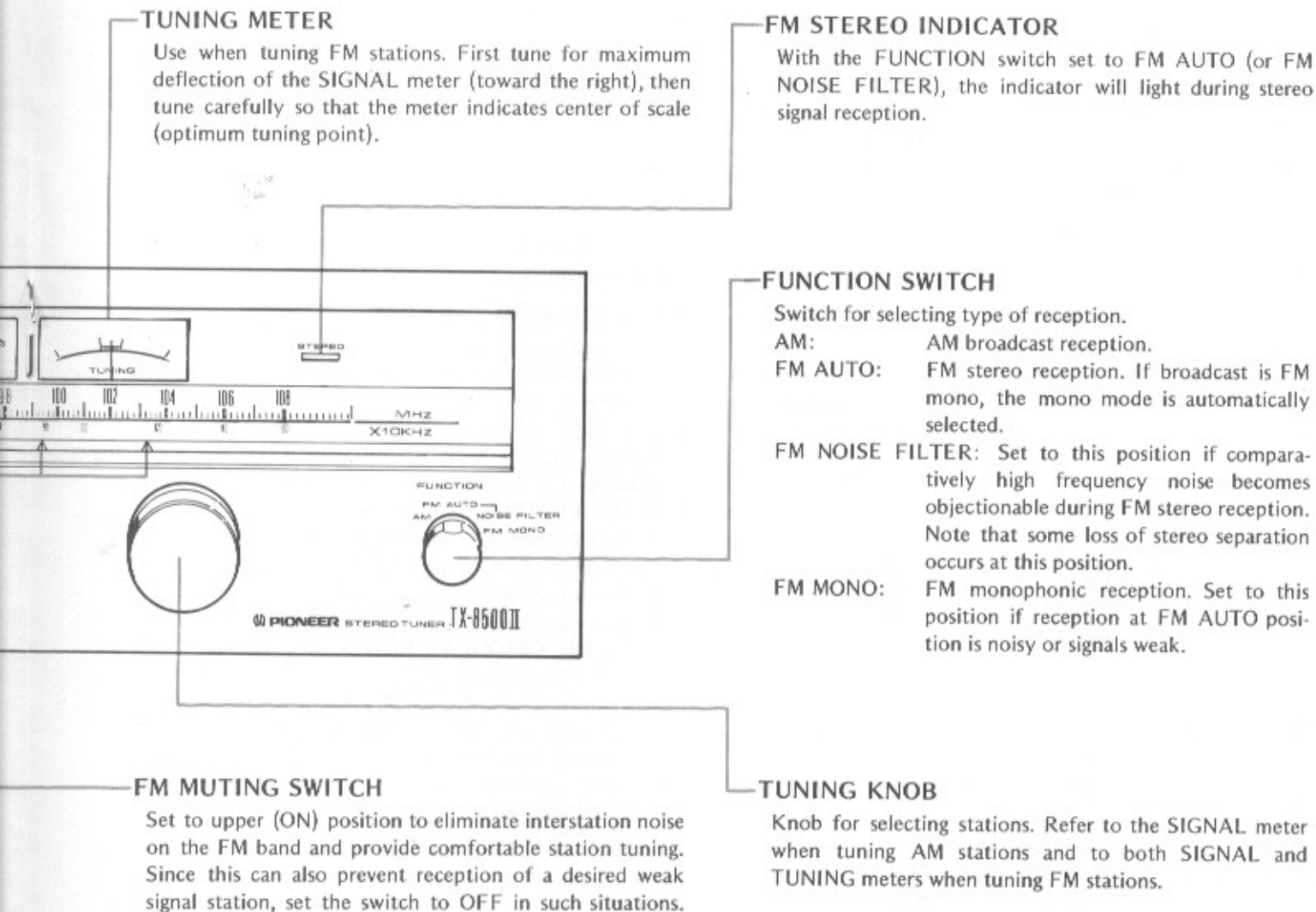

Fig. 7



AM RECEPTION

1. Set FUNCTION switch to AM.
2. Turn the TUNING knob to select desired station. Tune for maximum deflection of the SIGNAL meter toward the right, as shown in Fig. 8.

- If the stereo amplifier is connected to the OUTPUT (VARIABLE) jacks, volume can be adjusted by the OUTPUT LEVEL control.

NOTE:
If sensitivity is poor or reception noisy when listening to FM or AM receptions, refer to Page 4 "Antenna Connections" and inspect again the antenna installation.



Fig. 8

EFFECTIVE OPERATION

OUTPUT JACKS AND OUTPUT LEVEL CONTROL

Output level at the OUTPUT (VARIABLE) jacks can be adjusted by the front panel OUTPUT LEVEL control. In addition to the VARIABLE jacks, the FIXED jacks are provided with a fixed level output.

Employing VARIABLE Jacks

By connecting these to a stereo amplifier, the OUTPUT LEVEL control can be used to adjust the TX-8500II output to match those of other components connected to the stereo amplifier. This conveniently simplifies operation of the stereo amplifier in that it eliminates the need for readjusting its volume control when selecting program sources.

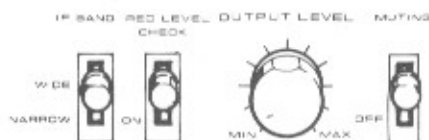
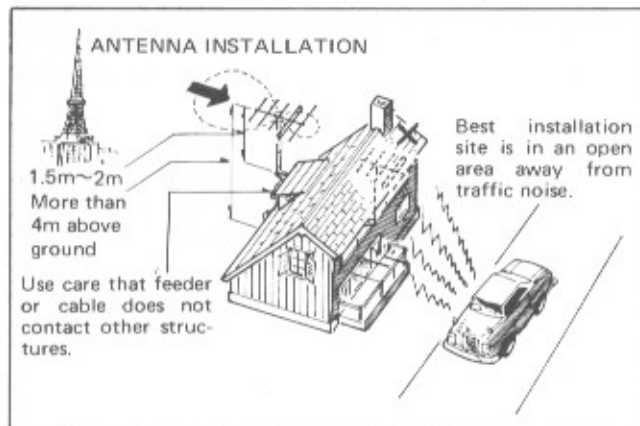

Fig. 9

IF BAND SWITCH

The IF passband of this tuner is selectable for NARROW and WIDE modes. If an interfering signal is adjacent to a desired station, setting the IF BAND switch to NARROW improves selectivity in order to avoid mixed signal problems. For example, if a strong signal station is close to a desired station, set the FM MUTING switch to OFF and this switch to NARROW to receive the desired station. Conversely, when adjacent signal problems are not present, set the switch to WIDE for improved sound quality reception.



REC LEVEL CHECK

Proper recording level setting of the tape deck is required for producing good quality recordings from FM broadcasts. This is ordinarily quite difficult since the output level of FM broadcasts varies continuously.

By setting the REC LEVEL CHECK switch to ON, a 440Hz reference signal at level corresponding to 50% FM modulation is produced. Optimum recording levels can then be set regardless of the program.

Setting Recording Level

1. Connect tape deck.
2. Set FUNCTION switch to FM position and tune in desired station.
3. Set REC LEVEL CHECK switch to ON. A 440Hz signal will be produced at approximately 1.7 second intervals at the OUTPUT (FIXED and VARIABLE) jacks.
4. Adjust recording levels of the tape deck so that its level meters deflect in the following ranges:
 - Open reel deck: 0 to +2dB
 - Cassette deck: Approximately -2dB
5. Set REC LEVEL CHECK switch to OFF and record FM program.

Since the output level of this signal is the same for left and right channels, it can also be employed as a convenient reference signal for adjusting the left and right channel balance of the stereo system connected to the OUTPUT jacks.

FM DET OUTPUT JACKS

In locations where discrete four channel FM programs are being broadcast, an adaptor for this format can be connected to these jacks.

FM MULTIPATH DISTORTION

Multipath distortion occurs when FM signals are reflected from interfering objects and enter the antenna from various directions, as shown in Fig. 10. Due to the different distances travelled by the reflected signals, the slight time difference with which they strike the antenna causes mutual interference. This results in phase distortion, distortion of received sound, reduced channel separation and SN ratio. Especially in locations where signals are weak, these effects become easily incurred. In order to minimize multipath distortion, use a sharply directional antenna and adjust antenna height and direction according to the following steps.

Adjustment Using Oscilloscope

1. As shown in Fig. 11, use good quality shielded cable to connect VERT (lower) and HORIZ (upper) MULTIPATH jacks to the vertical and horizontal input terminals of an oscilloscope.
2. Set FUNCTION switch to FM AUTO, tune in an FM station and adjust oscilloscope for a waveform display on the CRT.
3. Adjust antenna direction so that vertical waveform component becomes minimized as shown in Fig. 12-A.

NOTES:

- When multipath distortion is reduced, the horizontal component becomes nearly linear as shown in Fig. 12-A. If present in large amount, a vertical component (amplitude waveform) becomes apparent as in Fig. 12-B.
- If horizontal axis gain is insufficient for easy waveform observation when employing an oscilloscope for adjustment, instead of connecting the oscilloscope horizontal input to the MULTIPATH HORIZ jack, connect it to the OUTPUT VARIABLE L jack. In this case, the horizontal axis gain can then be adjusted with the OUTPUT LEVEL control.

Adjustment Using Stereo Amplifier

1. Connect rear panel MULTIPATH HORIZ (upper) jack to the tuner L jack of the stereo amplifier and the VERT (lower jack) to the tuner R jack (Fig. 13).
2. With the FUNCTION switch at FM AUTO, tune in FM station. Normal FM signal will be heard from the left channel, while the multipath sound (AM synthesis of reflected FM signals) will be audible from the right channel.
3. Use the balance control of the stereo amplifier to turn down the left channel sound and listen to the right channel sound. Adjust antenna direction so that right channel sound is minimized.
4. After completing this adjustment, return connections to normal condition to enjoy FM stereo reception.

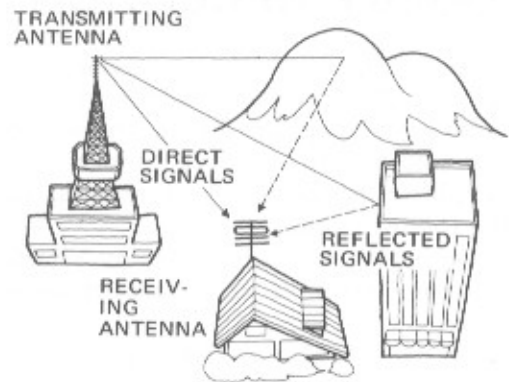

Fig. 10

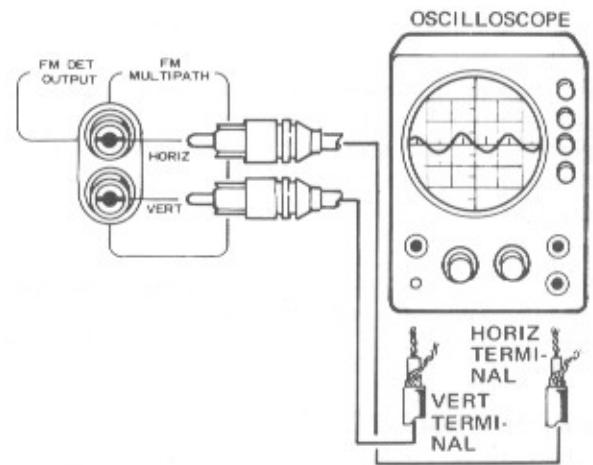

Fig. 11

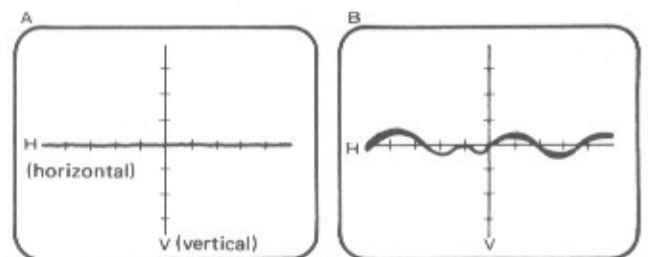

Fig. 12

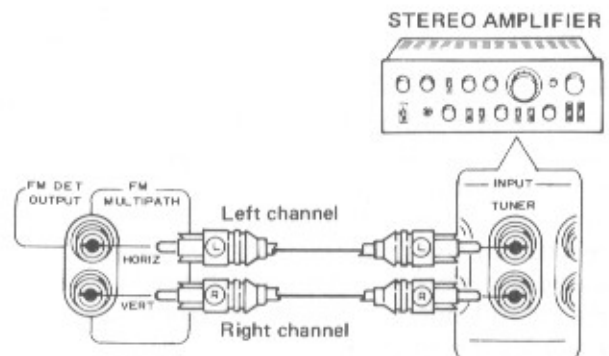

Fig. 13

FM-DOLBY RECEPTION

The FM DE-EMPHASIS switch is provided to allow reception of FM-Dolby broadcasts in locations where these programs are being transmitted. A separately sold adaptor must be connected to the stereo amplifier in this case, then proceed according to the following steps.

1. As shown in Fig. 14, connect Dolby NR adaptor to the tape (record & play) jacks of the stereo amplifier.
2. Set rear panel FM DE-EMPHASIS switch to $25\mu\text{s}$.
3. Set TAPE MONITOR switch of stereo amplifier to ON.
4. Set FUNCTION switch to FM position and use the TUNING knob to tune in FM-Dolby broadcast. Tuning is performed in the same manner as described in "FM Reception".
5. Operate adaptor and set for reception. Adjust volume and tone with the controls of the stereo amplifier.

NOTES:

- Refer to the Dolby NR adaptor operating instructions regarding connection and operation.
- When not listening to FM-Dolby broadcasts, be sure to set the FM DE-EMPHASIS switch to $75\mu\text{s}$.

FM DE-EMPHASIS SWITCH

1. Loosen lower screw, remove plastic cover and set switch to $25\mu\text{s}$.
2. Loosen upper screw, rotate plastic cover 180° and use this screw to secure.

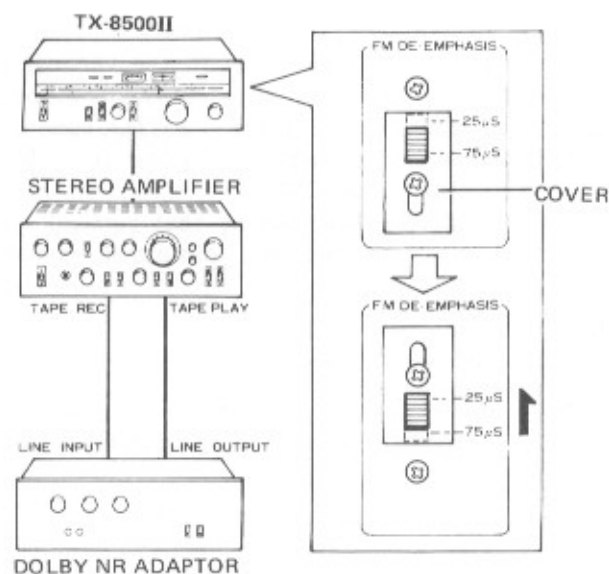
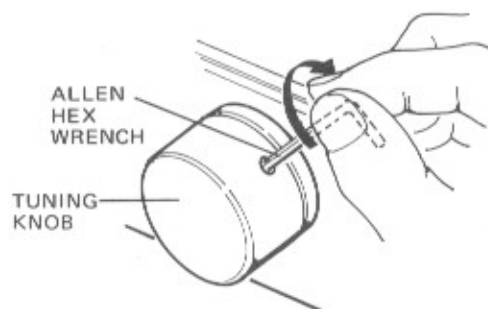

Fig. 14

ALLEN HEX WRENCH

The accessory Allen hex wrench is provided for removing the TUNING knob or tightening its setscrew in event it becomes loose.

If required, loosen the setscrew by inserting the wrench into the hole on the side of the knob and turning the wrench counterclockwise. Be particularly careful not to scratch the front panel when employing the wrench.



SPECIFICATIONS

Semiconductors

FETs	3
ICs	6
Transistors	11
Diodes	16

FM Section

Circuitry MOS FET 1-stage RF amplifier 4-gang variable capacitor, IF Band Selector, double balanced NFB type PLL MPX built-in pilot signal auto canceller.

Usable Sensitivity	MONO:	10.3dBf (1.8 μ V)
50dB Quieting Sensitivity	MONO:	16.1dBf (3.5 μ V)
	STEREO:	37.2dBf (40 μ V)

Signal-to-Noise Ratio at 65dBf	MONO:	79dB
	STEREO:	75dB

Distortion at 65dBf	MONO:	WIDE		NARROW	
		100Hz	0.1%	0.15%	
		1kHz	0.08%	0.15%	
		10kHz	0.1%	0.15%	
		15kHz	0.15%	—	
	STEREO:				
		100Hz	0.15%	0.4%	
		1kHz	0.1%	0.4%	
		10kHz	0.5%	0.9%	
		15kHz	0.8%	—	

Capture Ratio	0.8dB	2.0dB
Alternate Channel Selectivity	35dB	80dB
Stereo Separation	1kHz: 45dB	45dB
	50Hz to 15kHz: 35dB	30dB

Frequency Response 20Hz to 10kHz \pm 0.2dB
20Hz to 15kHz $^{+0.2}_{-0.5}$ dB

Spurious Response Ratio	90dB
Image Response Ratio	85dB
IF Response Ratio	100dB
AM Suppression Ratio	55dB
Muting Threshold	19.2dBf (5 μ V)
Subcarrier Product Ratio	72dB
SCA Rejection Ratio	62dB
Antenna Input	300ohms balanced 75ohms unbalanced

AM Section

Circuitry 1 stage RF amplifier 2-gang variable capacitor

Sensitivity	
IHF, ferrite antenna	300 μ V
IHF, external antenna	15 μ V
Selectivity	30dB
Signal-to-Noise Ratio	50dB
Image Response Ratio	45dB
IF Response Ratio	50dB
Antenna	Built-in ferrite loopstick antenna

Audio Section

Output (Level/Impedance)	
FM (100% MOD.)	FIXED: 650mV/4.2k Ω VARIABLE: 50mV to 1.3V/3.6k Ω
AM (30% MOD.)	FIXED: 200mV/4.2k Ω VARIABLE: 15mV to 400mV/3.6k Ω

Miscellaneous

Power Requirements	120V 60Hz only.
Power Consumption	20W
Dimensions	420(W)x150(H)x395(D) mm 16-9/16x5-7/8x15-9/16 in
Weight	Without Package: 8.1kg (17lb 14oz) With Package: 9.6kg (21lb 3oz)

Furnished Parts

FM T-type antenna	1
Operating Instructions	1
Connection Cord with Pin Plugs	1
Hex. Wrench (used for fastening Tuning knob)	1

NOTE:

Specifications and the design subject to possible modification without notice due to improvements.

CONDITIONS FREQUENTLY MISTAKEN FOR MALFUNCTION

If your stereo system appears to malfunction, first check such things as the controls (power switch, function selector, tape monitor, etc.) and connecting cords (components connected correctly).

Noise: There are a variety of noises relating to the operation of a hi-fi unit. These are generally divided into two types; (1) the unit is faulty (a transistor or part has deteriorated) and (2) an external source is adding to the unit.

When a hi-fi unit produces an unpleasant noise, it is

often assumed that the unit is faulty, but statistical records indicate that the majority of noises produced in hi-fi acoustic units result from external sources of noise: Due to the inherent high sensitivity and the high fidelity in reproduction, the unit amplifies and reproduces extraneous noises, however small, into definite output noise. If your tuner produces a noise, check according to the following table and trace out the source of noise for the appropriate corrective action.

	SYMPTOM	SUSPECTED SOURCE OF NOISE	DIAGNOSIS AND REMEDY
WHEN LISTENING TO BROADCASTS	Continuous or intermittent noise like jiiiii or zzzzzz.	<ul style="list-style-type: none"> ● Static (lightning) ● Fluorescent lamp, motor, or thermostat may be in use in house or in the vicinity of the house. 	In many cases, it is very difficult to remove the source of noise. In order to make the radio input larger than the noise level, set up a good outdoor antenna and make a complete grounding.
	When a station is tuned in, hum is mixed in the program.	<ul style="list-style-type: none"> ● Poor fluorescent lamp, motor, or electric heater may be in use in house or near the house. 	Reversing the line plug may occasionally alleviate this noise problem. Usually it is very difficult to eliminate the noise.
	Hissing sound noise in AM (medium wave) reception.	<ul style="list-style-type: none"> ● The frequency of an adjacent station is interfering with that of the station being tuned in (10kHz beat interference). ● TV set is on in the same house with the tuner. 	Impossible to remove such interference. If the cause of such noise is the TV set, increase the distance between the TV set and tuner.
	Static noise (in particular, when automobiles run close to the house).	<ul style="list-style-type: none"> ● White noise generated from automobile engines. ● High frequency sewing machine or welding machine being used near your house. 	In an area surrounded by hills or high buildings, the FM input signals are very weak. Thus the noise limiter in the circuit loses its function. Set up an FM outdoor antenna having many director elements.
	Reception of FM stereo program contains more noise than FM mono program.	<ul style="list-style-type: none"> ● Note that the service area covered by an FM stereo broadcast is about 50% of that of a regular mono broadcast. 	Increasing the FM input signal may alleviate this problem. Use an FM outdoor antenna instead of the indoor T-type antenna.

PIONEER ELECTRONIC CORPORATION

4-1, Meguro 1-Chome, Meguro-ku, Tokyo 153, Japan

U.S. PIONEER ELECTRONICS CORPORATION

75 Oxford Drive, Moonachie, New Jersey 07074, U.S.A.

PIONEER ELECTRONIC (EUROPE) N.V.

Luithagen-Haven 9, 2030 Antwerp, Belgium

PIONEER ELECTRONICS AUSTRALIA PTY. LTD.

178-184 Boundary Road, Braeside, Victoria 3195, Australia

Printed in Japan